



Kit per travaso benzina da fusti e cisterne ai sensi delle direttive ATEX/IECEx, con elettropompa a palette 12V - 230V. Composto da tubo di aspirazione telescopico in metallo, ghiera fissaggio da 2” con filtro per il collegamento al fusto e staffa di alloggiamento per la pistola, per facilitare l’uso del distributore.



Serie “Benz Kit” composta da:



Art. 091-5800-050 Pompa elettrica 230V 50Hz 50 l/min ATEX

Art. 091-5801-050 Pompa elettrica 12V 50 l/min ATEX



Art. 918-0500-040 Tubo di collegamento in gomma antistatico EN 12115 ATEX D.19x31 lunghezza 4 m



Art. 095-5284-000 Tubo di aspirazione telescopico con valvola di fondo M 1” lunghezza 495 <885 mm



Art. 093-5204-150 Pistola manuale SELF3000 portata 150 l/min



Art. 093-5321-060 Pistola automatica per benzina ZPA60 portata 60 l/min



Art. 093-5306-000 Staffa supporto pistola



Art. 095-5280-609 Ghiera fissaggio pompa M 1” - 2”

KIT POMPE ELETTRICHE PER TRAVASO BENZINA "Benz Kit"



Codice	Descrizione	Portata	Tensione	Potenza	Entrata Uscita	Tubo colleg.	Pistola	Ciclo di lavoro	Peso	Imballo
		l/min	AC V./Hz DC Volt	W	BSPG	Ø		ON/OFF min	kg	mm

090-5600-050	Benz Kit	50	230/50	250	F1" - F1"	20	Manuale	30/30	14,00	410X400X320
090-5600-Y50	Benz Kit	50	12	250	F1" - F1"	20	Manuale	30/60	14,00	410X400X320

090-5601-050	Benz Kit	50	230/50	250	F1" - F1"	20	Aut.ZPA60	30/30	14,50	410X400X320
090-5601-Y50	Benz Kit	50	12	250	F1" - F1"	20	Aut.ZPA60	30/60	14,50	410X400X320

Kit per travaso benzina da fusti e cisterne ai sensi delle direttive ATEX/IECEx, con elettropompa a palette 12V - 230V. Composto da tubo di aspirazione telescopico in metallo, ghiera fissaggio da 2” con filtro per il collegamento al fusto e staffa di alloggiamento per la pistola, per facilitare l’uso del distributore.



Serie “Benz Kit” composta da:



Art. 091-5800-050 Pompa elettrica 230V 50Hz 50 l/min ATEX

Art. 091-5801-050 Pompa elettrica 12V 50 l/min ATEX



Art. 918-0500-040 Tubo di collegamento in gomma antistatico EN 12115 ATEX D.19x31 lunghezza 4 m



Art. 095-5284-000 Tubo di aspirazione telescopico con valvola di fondo M 1” lunghezza 495 <885 mm



Art. 093-5204-150 Pistola manuale SELF3000 portata 150 l/min



Art. 093-5321-060 Pistola automatica per benzina ZPA60 - portata 60 l/min



Art. 094-5240-000 Filtro di mandata separatore d’acqua per Benzina 70 l/min



Art. 093-5306-000 Staffa supporto pistola



Art. 095-5280-609 Ghiera fissaggio pompa M 1” - 2”

KIT POMPE ELETTRICHE PER TRAVASO BENZINA "Benz Kit"



Codice	Descrizione	Portata	Tensione	Potenza	Entrata Uscita	Tubo colleg.	Pistola	Ciclo di lavoro	Peso	Imballo
		l/min	AC V./Hz DC Volt	W	BSPG	Ø		ON/OFF min	kg	mm

090-5602-050	Benz Kit	50	230/50	250	F1" - F1"	20	Manuale	30/30	15,00	410X400X320
090-5602-Y50	Benz Kit	50	12	250	F1" - F1"	20	Manuale	30/60	15,00	410X400X320

090-5603-050	Benz Kit	50	230/50	250	F1" - F1"	20	Aut.ZPA60	30/30	15,50	410X400X320
090-5603-Y50	Benz Kit	50	12	250	F1" - F1"	20	Aut.ZPA60	30/60	15,50	410X400X320

Kit per travaso benzina da fusti e cisterne ai sensi delle direttive ATEX/IECEX, con elettropompa a palette 12V - 230V. Composto da tubo di aspirazione telescopico in metallo, ghiera fissaggio da 2” con filtro per il collegamento al fusto e staffa di alloggiamento per la pistola, per facilitare l’uso del distributore.



Serie “Benz Kit” composta da:



Art. 091-5800-050 Pompa elettrica 230V 50Hz 50 l/min ATEX

Art. 091-5801-050 Pompa elettrica 12V 50 l/min ATEX



Art. 918-0500-040 Tubo di collegamento in gomma antistatico EN 12115 ATEX D.19x31 lunghezza 4 m



Art. 095-5284-000 Tubo di aspirazione telescopico con valvola di fondo M 1” lunghezza 495 <885 mm



Art. 092-5160-000 Contalitri meccanico per Benzina ATEX min-max Portata 20-120 l/min



Art. 093-5204-150 Pistola manuale SELF3000 portata 150 l/min



Art. 093-5321-060 Pistola automatica per benzina ZPA60 - portata 60 l/min



Art. 094-5240-000 Filtro di mandata separatore d’acqua per Benzina 70 l/min



Art. 093-5306-000 Staffa supporto pistola



Art. 095-5280-609 Ghiera fissaggio pompa M 1” - 2”

KIT POMPE ELETTRICHE PER TRAVASO BENZINA "Benz Kit"



Codice	Descrizione	Portata	Tensione	Potenza	Entrata Uscita	Tubo coll.	Pistola	Conta Litri	Ciclo di lavoro	Peso	Imballo
		l/min	AC V/Hz DC Volt	W	BSPG	Ø			ON/OFF min	kg	mm
090-5604-050	Benz Kit	50	230/50	250	F1" - F1"	20	Manuale	SI	30/30	17,00	550X400X320
090-5604-Y50	Benz Kit	50	12	250	F1" - F1"	20	Manuale	SI	30/60	17,00	550X400X320
090-5605-050	Benz Kit	50	230/50	250	F1" - F1"	20	Aut.ZPA60	SI	30/30	17,50	550X400X320
090-5605-Y50	Benz Kit	50	12	250	F1" - F1"	20	Aut.ZPA60	SI	30/60	17,50	550X400X320

Serbatoio per il trasporto di Benzina per uso privato in esenzione totale secondo informativa ADR (vedi a pag. 180 informativa ADR). Tappo di carico in alluminio con valvola di sicurezza integrata, filtro in linea per l'aspirazione, gruppo di travaso, pistola automatica lucchettabile. Completo di pompa volumetrica in versione ATEX, cavo di messa a terra con pinza, cavi lunghezza 4 m per il collegamento alla batteria e 4 m di tubo flessibile per carburante. Coperchio rinforzato e lucchettabile.



Serie “Benz-Tank” composta da:



Art. 090-7220-000 Serbatoio 220 l Senza pompa



Art. 091-5801-050 Pompa elettrica 12V 50 l/min ATEX con pinze e fusibile



Art. 092-5161-000 Contalibri digitale per Benzina Atex min-max Portata 7-120 l/min



Art. 918-0500-040 Tubo di collegamento in gomma antistatico EN 12115 ATEX D.19x31 lunghezza 4 m



Art. 093-5321-060 Pistola automatica per benzina ZPA60 - portata 60 l/min

SERBATOIO IN POLIETILENE TRASPORTO BENZINA "Benz-Tank"



Codice	Descrizione	Portata	Tensione	Potenza	Entrata Uscita	Tubo col.	Pistola	Conta litri	Ciclo lavoro	Peso	Imballo
		l/min	DC Volt	W	BSPG	Ø			min	Kg	mm

090-7220-012	Benz-Tank	50	12	250	F1" - F1"	19	Aut. ZPA60	NO	30/60	24,00	910X600X665
---------------------	-----------	-----------	----	-----	-----------	----	------------	----	-------	-------	-------------

090-7221-012	Benz-Tank	50	12	250	F1" - F1"	19	Aut. ZPA60	SI	30/60	24,50	910X600X665
---------------------	-----------	-----------	----	-----	-----------	----	------------	----	-------	-------	-------------

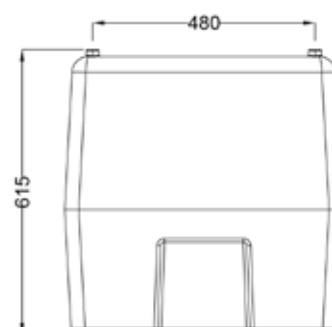
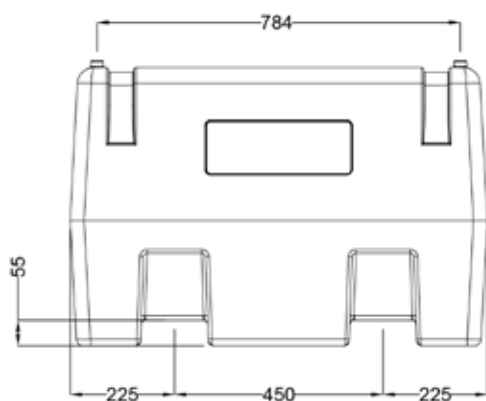

Serbatoio in polietilene rigido per il trasporto Benzina per uso professionale e privato in esenzione ADR (vedi a pag. 180 informativa ADR), ideale per il rifornimento di piccoli veicoli operativi e mezzi leggeri o da diporto, sono dotate inoltre di ruote antiforatura ed adatte agli spostamenti su qualsiasi superficie, hanno dimensioni compatte per una facile movimentazione. Ogni contenitore può essere riempito sia in verticale che in orizzontale, con la stessa quantità di carburante. Dotato di staffa supporto pistola, valvola a sfera di sicurezza con giunto girevole, tappo di carico con valvola di sfiato antisversamento.



Serie “Caddy” composta da:

Art. 090-7055-M00 Serbatoio carrellato Caddy 55 l Benzina



Art. 027-3720-000 Pompa rotativa manuale in alluminio



Art. 918-0500-040 Tubo di collegamento in gomma antistatico
EN 12115 ATEX D.19x31 lunghezza 4 m



Art. 093-5204-150 Pistola manuale SELF3000 portata 150 l/min

SERBATOIO PER TRASPORTO BENZINA “Caddy”



55 l

Codice	Descrizione	Capacità per 100 giri		Larghezza	Profondità	Altezza	Pistola	Peso	Imballo
		l	USG						
		38	10	460	360	900		9,00	1000X500X500

Elettropompe 12V e 230V indicate per il travaso di carburante infiammabile come benzina, Kerosene e gasolio, con termica di protezione inserita nell'avvolgimento. Le elettropompe per travaso benzina soddisfano i criteri delle severe direttive ATEX / IECEX relative all'utilizzo di materiali in atmosfere potenzialmente esplosive



Art. 091-5800-050
Pompa elettrica per travaso Benzina ATEX
230V-50Hz portata 50l/min

Cavo di alimentazione lunghezza 2 m, con spina Schuko
 Corpo in Ghisa
 Alta efficienza del motore con ridotto assorbimento
 Filtro antidisturbo (compatibilità elettromagnetica EMC)
 Valvola di By pass incorporata
 Protezione termica.

Art. 091-5801-050
Pompa elettrica per travaso Benzina ATEX
12V portata 50l/min

Cavo di alimentazione lunghezza 2 m, con pinze e fusibile di protezione
 Corpo in Ghisa
 Alta efficienza del motore con ridotto assorbimento
 Filtro antidisturbo (compatibilità elettromagnetica EMC)
 Valvola di By pass incorporata
 Protezione termica.

Codice	Portata	Tensione	Potenza	Corrente	LCavo alimentaz.	Entrata Uscita	Ciclo di lavoro	Peso	Imballo
	l/min	AC V./Hz DC Volt	W	A	m	BSPG	ON/OFF min	kg	mm

091-5800-050	50	230/50	250	1,2	2	F 1"-F 1"	30/30	8,80	390X195X260
---------------------	-----------	--------	-----	-----	---	-----------	-------	------	-------------

091-5801-050	50	12	250	21	2	F 1"-F 1"	30/60	8,80	390X195X260
---------------------	-----------	----	-----	----	---	-----------	-------	------	-------------

Contaltri per uso privato per la misurazione della quantità erogata di Benzina, Kerosene e Gasolio. Questi articoli soddisfano i requisiti ATEX / IECx relativi all'utilizzo di materiali in atmosfere potenzialmente esplosivi. Disponibile nella versione meccanico e digitale.

Art. 092-5160-000 Contaltri meccanico per Benzina ATEX min-max Portata 20-120 l/min



6 cifre totalizzatore
3 cifre totalizzatore parziale
Fluidi ammessi: Benzina
Unità di misura: L (litri)

Art. 092-5161-000 Contaltri digitale per Benzina ATEX min-max Portata 7-120 l/min



6 cifre totalizzatore
5 cifre totalizzatore parziale
Fluidi ammessi: Benzina, Gasolio, Kerosene
Unità di misura: L (litri), G (U.S. galloni), Q (Quarti), P (Pinte)

Art. 093-5204-150 Pistola manuale SELF3000 portata 150 l/min per travaso benzina

Portata 150 l/min
Corpo in plastica con estremità in alluminio
Raccordo girevole F 1"



Art. 093-5321-060 Pistola automatica ZPA60 portata 60 l/min per travaso benzina ATEX

Portata 60 l/min
Corpo in alluminio
Raccordo girevole F 1"



Codice	Portata	Pressione	Tolleranza	Entrata - Uscita	Peso	Imballo
	l/min	bar	%	BSPG	Kg	mm



092-5160-000	20-120	3,5	+/- 1	F 1" - F 1"	2,15	240X190X190
092-5161-000	7-120	20	+/- 1	M 1" - F 1"	0,6	115X160X135

Codice	Modello	Fluido	Portata	Entrata	Peso	Ø estremità	Imballo
		tipo	l/min	BSPG	Kg	mm	mm

093-5204-150	SELF3000	Benzina	150	F 1"	1,20	20,00	400X175X57
093-5321-060	ZPA60	Benzina	60	F 1"	1,20	20,50	400X175X57

Dotati di:

- Tubi in gomma sintetica nera antistatica con spirale metallica incorporata tessuti sintetici ad alta resistenza e cordicella di rame
- Normative di riferimento: EN 1761 - EN 12115 ATEX (EX ZONE)
- Resistente alla fiamma secondo: TRbf 131/2
- Raccordi in acciaio zincato
- Giunto girevole 90° in acciaio zincato - Guarnizioni in Viton®
- Conforme alla direttiva ATEX



 II 2 G Ex h IIB T4 Gb X
 II 2 D Ex h IIIC T4 Db



F-550

Articolo	Capacità	L. tubo	Ø tubo	Entrata-Uscita
070-1418-600	95 l/min	senza tubo	-	F1"-M1" BSP
070-1418-510	90 l/min	10 m	3/4"- 19x27	F1"-M1" BSP
070-1418-515	85 l/min	15 m	3/4"- 19x27	F1"-M1" BSP
070-1418-610	95 l/min	10 m	1" - 25x35	F1"-M1" BSP



F-555

Articolo	Capacità	L. tubo	Ø tubo	Entrata-Uscita
070-1518-600	95 l/min	senza tubo	-	F1"-M1" BSP
070-1518-520	83 l/min	20 m	3/4"- 19x27	F1"-M1" BSP
070-1518-615	90 l/min	15 m	1" - 25x35	F1"-M1" BSP



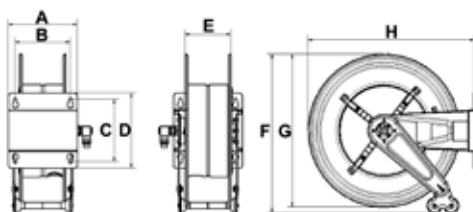

F-560

Articolo	Capacità	L. tubo	Ø tubo	Entrata-Uscita
070-1618-600	95 l/min	senza tubo	-	F1"-M1" BSP
070-1618-530	80 l/min	30 m	3/4"- 19x27	F1"-M1" BSP
070-1618-620	87 l/min	20 m	1" - 25x35	F1"-M1" BSP
070-1618-630	85 l/min	30 m	1" - 25x35	F1"-M1" BSP



DIMENSIONI DI INGOMBRO FISSI

Mod.	A	B	C	D	E	F	G	H			
F-550	200	150	225	270	120	590	550	600	22,00<45,00	0,130	1
F-555	250	200	225	270	170	590	550	600	26,00<53,00	0,150	1
F-560	440	390	225	270	360	590	550	600	33,00<83,00	0,240	1

AVVOLGITUBO AUTOMATICI IN ACCIAIO VERNICIATO ORIENTABILI PER BENZINE 16 bar



Dotati di:

- Tubi in gomma sintetica nera antistatica con spirale metallica incorporata tessuti sintetici ad alta resistenza e cordicella di rame
- Normative di riferimento: EN 1761 - EN 12115 ATEX (EX ZONE)
- Resistente alla fiamma secondo: TRbf 131/2
- Raccordi in acciaio zincato
- Giunto girevole 90° in acciaio zincato - Guarnizioni in Viton®
- Conforme alla direttiva ATEX

CE Ex II 2 G Ex h IIB T4 Gb X
II 2 D Ex h IIIC T4 Db

Articolo	Capacità	L. tubo	Ø tubo	Entrata-Uscita
071-1418-600	95 l/min	senza tubo	-	F1"-M1" BSP
071-1418-510	90 l/min	10 m	3/4"- 19x27	F1"-M1" BSP
071-1418-515	85 l/min	15 m	3/4"- 19x27	F1"-M1" BSP
071-1418-610	95 l/min	10 m	1" - 25x35	F1"-M1" BSP

S-550



Articolo	Capacità	L. tubo	Ø tubo	Entrata-Uscita
071-1518-600	95 l/min	senza tubo	-	F1"-M1" BSP
071-1518-520	83 l/min	20 m	3/4"- 19x27	F1"-M1" BSP
071-1518-615	90 l/min	15 m	1" - 25x35	F1"-M1" BSP

S-555



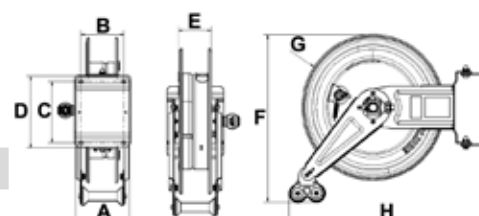

DIMENSIONI DI INGOMBRO ORIENTABILI

Mod.	A	B	C	D	E	F	G	H	Kg	m ³	N°
S-550	200	150	225	270	120	572	550	680	23,00<45,00	0,130	1
S-555	250	200	225	270	170	572	550	680	27,00<54,00	0,150	1



Dotati di:

- Tubi in gomma sintetica nera antistatica con spirale metallica incorporata tessuti sintetici ad alta resistenza e cordicella di rame
- Normative di riferimento: EN 1761 - EN 12115 ATEX (EX ZONE)
- Resistente alla fiamma secondo: TRbf 131/2
- Raccordi in acciaio zincato
- Giunto girevole 90° in acciaio inox - Guarnizioni in Viton®
- Conforme alla direttiva ATEX



 II 2 G Ex h IIB T4 Gb X
 II 2 D Ex h IIIC T4 Db



FX-550

Articolo	Capacità	L. tubo	Ø tubo	Entrata-Uscita
070-2418-600	95 l/min	senza tubo	-	F1"-M1" BSP
070-2418-510	90 l/min	10 m	3/4"- 19x27	F1"-M1" BSP
070-2418-515	85 l/min	15 m	3/4"- 19x27	F1"-M1" BSP
070-2418-610	95 l/min	10 m	1" - 25x35	F1"-M1" BSP



FX-555

Articolo	Capacità	L. tubo	Ø tubo	Entrata-Uscita
070-2518-600	95 l/min	senza tubo	-	F1"-M1" BSP
070-2518-520	83 l/min	20 m	3/4"- 19x27	F1"-M1" BSP
070-2518-615	90 l/min	15 m	1" - 25x35	F1"-M1" BSP



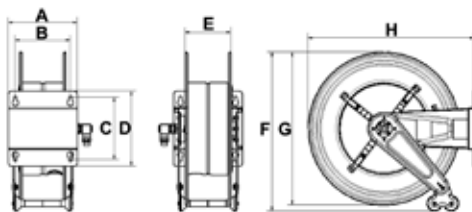

FX-560

Articolo	Capacità	L. tubo	Ø tubo	Entrata-Uscita
070-2618-600	95 l/min	senza tubo	-	F1"-M1" BSP
070-2618-530	80 l/min	30 m	3/4"- 19x27	F1"-M1" BSP
070-2618-620	87 l/min	20 m	1" - 25x35	F1"-M1" BSP
070-2618-630	85 l/min	30 m	1" - 25x35	F1"-M1" BSP



DIMENSIONI DI INGOMBRO FISSI

Mod.	A	B	C	D	E	F	G	H			
FX-550	200	150	225	270	120	590	550	600	22,00<45,00	0,130	1
FX-555	250	200	225	270	170	590	550	600	26,00<53,00	0,150	1
FX-560	440	390	225	270	360	590	550	600	33,00<83,00	0,240	1

AVVOLGITUBO AUTOMATICI IN ACCIAIO INOX AISI 304 ORIENTABILI PER BENZINE 16 bar



Dotati di:

- Tubi in gomma sintetica nera antistatica con spirale metallica incorporata tessuti sintetici ad alta resistenza e cordicella di rame
- Normative di riferimento: EN 1761 - EN 12115 ATEX (EX ZONE)
- Resistente alla fiamma secondo: TRbf 131/2
- Raccordi in acciaio zincato
- Giunto girevole 90° in acciaio inox - Guarnizioni in Viton®
- Conforme alla direttiva ATEX

CE Ex II 2 G Ex h IIB T4 Gb X
II 2 D Ex h IIIC T4 Db

Articolo	Capacità	L. tubo	Ø tubo	Entrata-Uscita	SX-550
071-2418-600	95 l/min	senza tubo	-	F1"-M1" BSP	
071-2418-510	90 l/min	10 m	3/4"- 19x27	F1"-M1" BSP	
071-2418-515	85 l/min	15 m	3/4"- 19x27	F1"-M1" BSP	
071-2418-610	95 l/min	10 m	1" - 25x35	F1"-M1" BSP	



Articolo	Capacità	L. tubo	Ø tubo	Entrata-Uscita	SX-555
071-2518-600	95 l/min	senza tubo	-	F1"-M1" BSP	
071-2518-520	83 l/min	20 m	3/4"- 19x27	F1"-M1" BSP	
071-2518-615	90 l/min	15 m	1" - 25x35	F1"-M1" BSP	



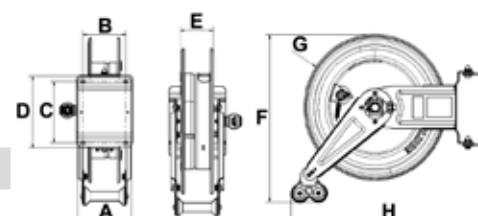

DIMENSIONI DI INGOMBRO ORIENTABILI

Mod.	A	B	C	D	E	F	G	H	Kg	m ³	N°
SX-550	200	150	225	270	120	572	550	680	23,00<45,00	0,130	1
SX-555	250	200	225	270	170	572	550	680	27,00<54,00	0,150	1



Dotati di:

- Tubi in gomma sintetica nera antistatica con spirale metallica incorporata tessuti sintetici ad alta resistenza e cordicella di rame
- Normative di riferimento: EN 1761 - EN 12115 ATEX (EX ZONE)
- Resistente alla fiamma secondo: TRbf 131/2
- Raccordi in acciaio zincato
- Giunto girevole 90° in acciaio zincato - Guarnizioni in Viton®
- **Conforme alla direttiva ATEX**



 II 2 G Ex h IIB T4 Gb X
 II 2 D Ex h IIIC T4 Db



HD-550	Articolo	Capacità	L. tubo	Ø tubo	Entrata-Uscita
	073-1418-600	95 l/min	senza tubo	-	F1"-M1" BSP
	073-1418-510	90 l/min	10 m	3/4"- 19x27	F1"-M1" BSP
	073-1418-515	85 l/min	15 m	3/4"- 19x27	F1"-M1" BSP
	073-1418-610	95 l/min	10 m	1" - 25x35	F1"-M1" BSP





HD-555	Articolo	Capacità	L. tubo	Ø tubo	Entrata-Uscita
	073-1518-600	95 l/min	senza tubo	-	F1"-M1" BSP
	073-1518-520	83 l/min	20 m	3/4"- 19x27	F1"-M1" BSP
	073-1518-615	90 l/min	15 m	1" - 25x35	F1"-M1" BSP

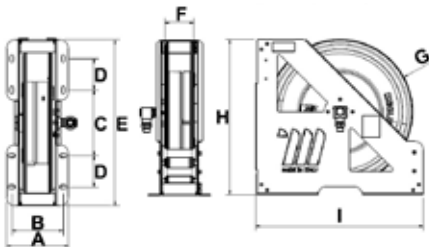

HD-560	Articolo	Capacità	L. tubo	Ø tubo	Entrata-Uscita
	073-1618-600	95 l/min	senza tubo	-	F1"-M1" BSP
	073-1618-530	80 l/min	30 m	3/4"- 19x27	F1"-M1" BSP
	073-1618-620	87 l/min	20 m	1" - 25x35	F1"-M1" BSP
	073-1618-630	85 l/min	30 m	1" - 25x35	F1"-M1" BSP



DIMENSIONI DI INGOMBRO FISSI



Mod.	A	B	C	D	E	F	G	H	I			
HD-550	230	197	324	100	644	120	550	597	649	40,45<51,00	0,120	1
HD-555	280	247	324	100	644	170	550	597	649	51,94<66,00	0,145	1
HD-560	460	427	324	100	644	350	550	597	649	61,30<85,00	0,230	1

AVVOLGITUBO AUTOMATICI IN ACCIAIO INOX AISI 304 SERIE HEAVY - DUTY PER BENZINE 16 bar



Dotati di:

- Tubi in gomma sintetica nera antistatica con spirale metallica incorporata tessuti sintetici ad alta resistenza e cordicella di rame
- Normative di riferimento: EN 1761 - EN 12115 ATEX (EX ZONE)
- Resistente alla fiamma secondo: TRbf 131/2
- Raccordi in acciaio zincato
- Giunto girevole 90° in acciaio inox - Guarnizioni in Viton®
- Conforme alla direttiva ATEX



 II 2 G Ex h IIB T4 Gb X
 II 2 D Ex h IIIC T4 Db

Articolo	Capacità	L. tubo	Ø tubo	Entrata-Uscita	HDX-550
073-2418-600	95 l/min	senza tubo	-	F1"-M1" BSP	
073-2418-510	90 l/min	10 m	3/4"- 19x27	F1"-M1" BSP	
073-2418-515	85 l/min	15 m	3/4"- 19x27	F1"-M1" BSP	
073-2418-610	95 l/min	10 m	1" - 25x35	F1"-M1" BSP	





Articolo	Capacità	L. tubo	Ø tubo	Entrata-Uscita	HDX-555
073-2518-600	95 l/min	senza tubo	-	F1"-M1" BSP	
073-2518-520	83 l/min	20 m	3/4"- 19x27	F1"-M1" BSP	
073-2518-615	90 l/min	15 m	1" - 25x35	F1"-M1" BSP	



Articolo	Capacità	L. tubo	Ø tubo	Entrata-Uscita	HDX-560
073-2618-600	95 l/min	senza tubo	-	F1"-M1" BSP	
073-2618-530	80 l/min	30 m	3/4"- 19x27	F1"-M1" BSP	
073-2618-620	87 l/min	20 m	1" - 25x35	F1"-M1" BSP	
073-2618-630	85 l/min	30 m	1" - 25x35	F1"-M1" BSP	



DIMENSIONI DI INGOMBRO FISSI

Mod.	A	B	C	D	E	F	G	H	I			
HDX-550	230	197	324	100	644	120	550	597	649	40,45<51,00	0,120	1
HDX-555	280	247	324	100	644	170	550	597	649	51,94<66,00	0,145	1
HDX-560	460	427	324	100	644	350	550	597	649	61,30<85,00	0,230	1

